

Front Compartment Front Rail Sectioning

Removal Procedure

Caution: Refer to [Approved Equipment for Collision Repair Caution](#) in Cautions and Notices.

Caution: Sectioning should be performed only in the recommended areas. Failure to do so may compromise the structural integrity of the vehicle and cause personal injury if the vehicle is in a collision.

1. Disable the SIR system. Refer to [SIR Disabling and Enabling](#) .
2. Disconnect the negative battery cable. Refer to [Battery Negative Cable Disconnection and Connection](#) .

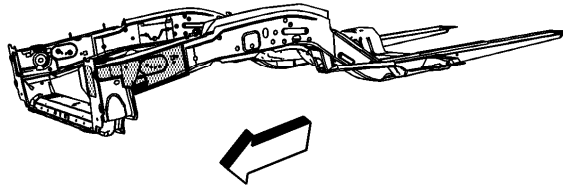

3. Remove all of the related panels and the components.
4. Remove the sealers and anti-corrosion materials from the repair area, as necessary. Refer to [Anti-Corrosion Treatment and Repair](#) .
5. Repair as much of the damage as possible to factory specifications. Refer to [Dimensions - Body](#) .

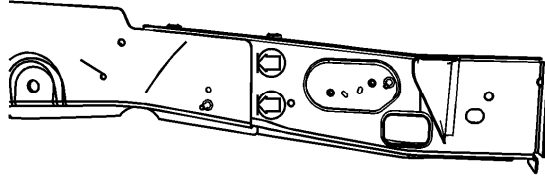

6. Locate the die marks on the outer side of the front rail .

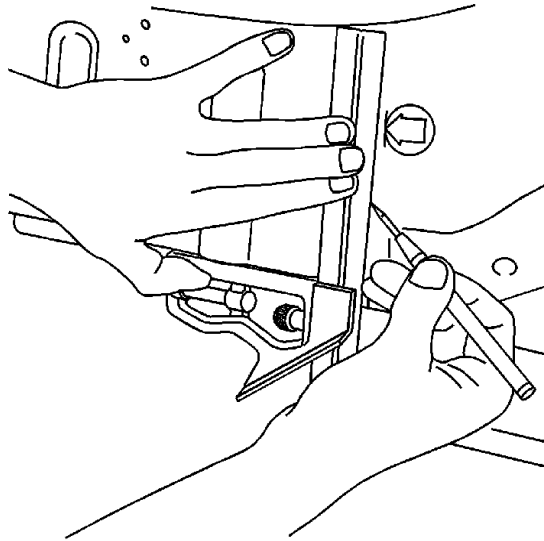

Important: Do not section the rail except where indicated.

7. At the tip of the arrow in the die mark, align a sliding square or similar tool to the bottom side of the front rail. Scribe a line 360 degrees around the frame rail.

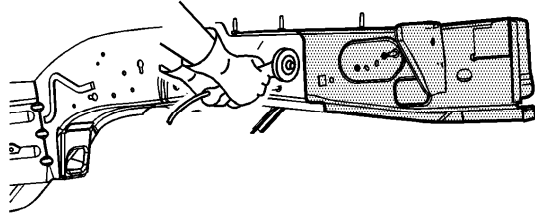

8. Cut the rail at the marked location.

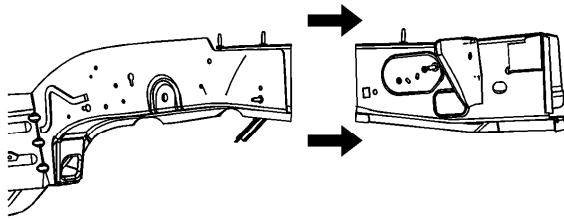

9. Remove the damaged component from the vehicle.

Installation Procedure

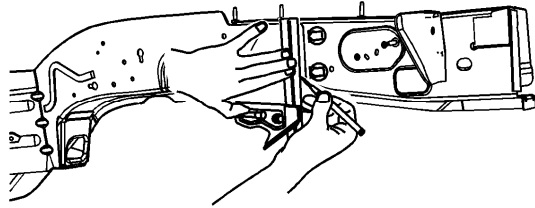

1. In order to create the service part, complete the following steps:
 - 1.1. Measure 10 mm (3/8 in) rearward of the back side of the die mark. Align a sliding square or similar tool to this line. Scribe a line completely around the frame rail.
 - 1.2. Cut the rail at the marked located.
 - 1.3. Remove the front portion of the rail. This is the service part.

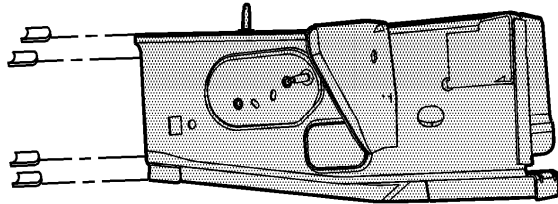

2. Cut the upper and lower inner and outer corners of the frame rail. Cut at the beginning and the end of the radius at each corner rearward 10 mm (3/8 in) to the scribe line.
3. Bend each side of the rail inward by aligning a vice grip flanging tool or similar tool to the scribe line. Bend a 10 mm (3/8 in) flange inward slightly. This flange is the welding backer that will fit into the existing frame rail on the vehicle.

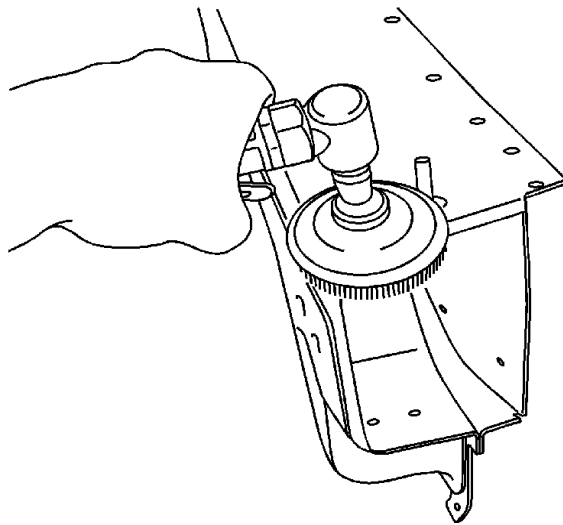

4. Prepare the sectioning weld area as necessary for welding.
5. Apply GM-approved Weld-Thru Coating or equivalent to all mating surfaces. Refer to [Anti-Corrosion Treatment and Repair](#).
6. Insert the service rail into the undamaged frame rail of the vehicle.

Important: Allow for a snug fit.

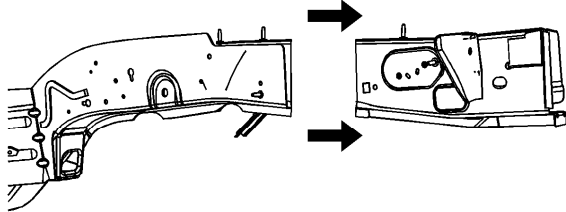

7. Position the front rail section using 3-dimensional measuring equipment. Clamp the service part in place.

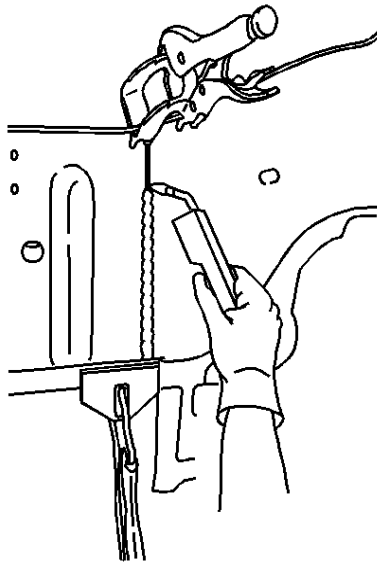

8. Tack weld the part into position.
9. Inspect the service rail for proper dimensions using 3-dimensional measuring equipment.
10. Stitch weld along the entire sectioning joint. Make 25 mm (1 in) welds along the seam with 25 mm (1 in) gaps between.
11. Complete the stitch weld.

12. Clean and prepare the welded surfaces.
13. Install all of the related panels and components.
14. Apply the sealers and anti-corrosion materials to the repair area, as necessary.
Refer to [Anti-Corrosion Treatment and Repair](#) .
15. Paint the repaired area. Refer to [Anti-Corrosion Treatment and Repair](#) .
16. Enable the SIR system. Refer to [SIR Disabling and Enabling](#) .
17. Connect the negative battery cable. Refer to [Battery Negative Cable Disconnection and Connection](#) .