

Body Lock Pillar Inner Panel Sectioning Replacement

Removal Procedure

Caution: Refer to [Approved Equipment for Collision Repair Caution](#) in Cautions and Notices.

Caution: Sectioning should be performed only in the recommended areas. Failure to do so may compromise the structural integrity of the vehicle and cause personal injury if the vehicle is in a collision.

1. The body side inner panel is available in one piece. Sectioning must take place in specified areas only.

Remove all related panels and components.

2. Disable the SIR system. Refer to [SIR Disabling and Enabling](#) in SIR.
3. Disconnect the negative battery cable. Refer to [Battery Negative Cable Disconnection and Connection](#) in Engine Electrical.
4. Remove the sealers and anti-corrosion materials from the repair area, as necessary and note their location. Refer to [Anti-Corrosion Treatment and Repair](#) in Paint and Coatings.

5. Repair as much of the damaged area as possible. Refer to [Dimensions - Body](#) .

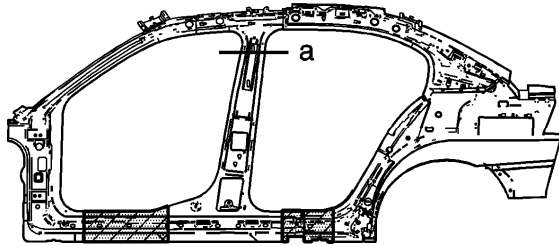

6. At the center pillar, locate the top shoulder belt attachment hole (a).

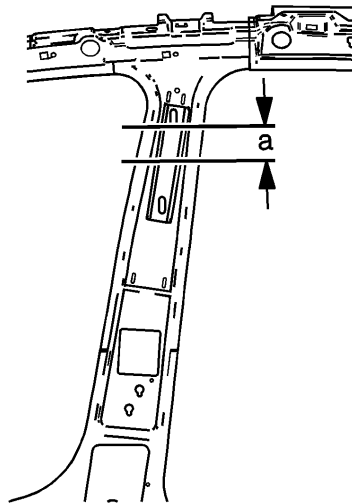

7. From the bottom of the shoulder belt attachment hole (a), measure down 50 mm (2 in). Scribe a line.

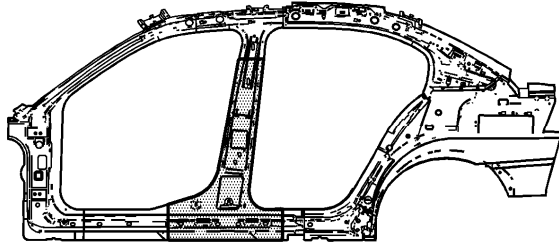

Important: Sectioning procedures can only take place in the straight areas of the inner body side panel.

8. Measure from any key feature in the panel. Lay out the cut line location on the inner body side panel.
9. Create cut lines on the rocker panel within the approved sectioning locations as needed.
10. Cut the panel at the inner center pillar where the lay out line was scribed.

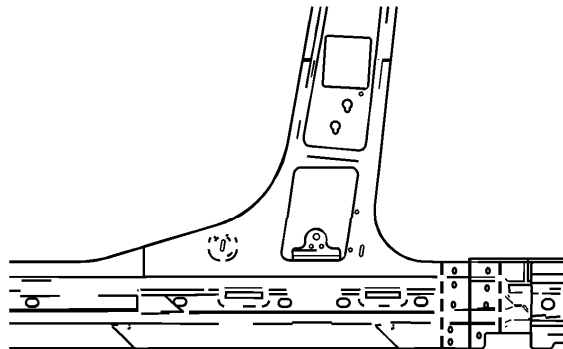

11. Cut the panel at the rocker panel area where sectioning is to be performed, within the straight sections only.

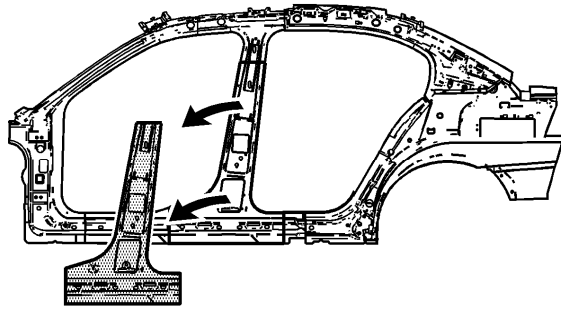

12. Locate and drill out all factory welds. Note the number and location of welds for installation of the service part.
13. Remove the damaged center pillar.

Installation Procedure

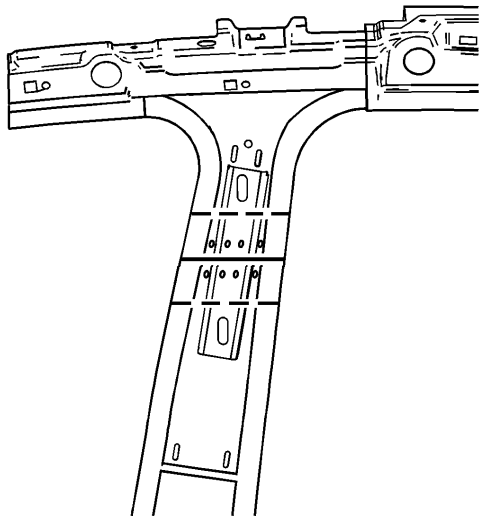

1. Cut the outer center pillar in corresponding locations to fit the remaining original panel. The sectioning joint should be trimmed to allow a gap of 1½ times the metal thickness at the sectioning joint.
2. In all the rocker panel areas, create a 100 mm (4 in) backing plate from the unused portion of the service part. Trim the backing plates as necessary to fit behind the sectioning joint.
3. In the upper inner center pillar area, cut a 50 mm (4 in) backing plate from the unused portion of the source part trim as necessary.

Important: If the location of the original plug weld holes can not be determined, space the plug weld holes every 40 mm (1½ in) apart.

4. Drill 8 mm (5/16 in) along the sectioning cuts on the remaining original part. Locate these holes 13 mm (½ in) from the edge of the part and spaced 40 mm (1½ in) apart.
5. Drill 8 mm (5/16 in) plug weld holes in the service part as necessary in the corresponding locations noted on the original panel.
6. Prepare all mating surfaces for welding as necessary.
7. Apply GM-approved Weld-Thru Coating or equivalent to all mating surfaces. Refer to [Anti-Corrosion Treatment and Repair](#).
8. Fit the backing plates into the sectioning joints for the following distances:
 - 100 mm (4 in) for the rocker section
 - 50 mm (2 in) for the center pillar section
10. Clamp the backing plates in place. Plug weld the backing plates to the vehicle.
11. Position the outer center pillar to the vehicle using 3-dimensional measuring equipment. Clamp the pillar in place.

12. Plug weld accordingly.

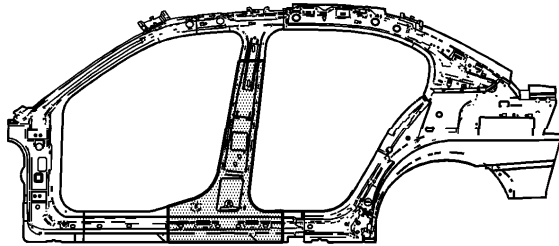

13. To create a solid weld with minimum heat distortion, make a 25 mm (1 in) stitch weld along the seam with gaps of 25 mm (1 in). Go back and complete the stitch weld.
14. Clean and prepare all of the welded surfaces.
15. Apply the sealers and anti-corrosion materials to the repair area, as necessary. Refer to [Anti-Corrosion Treatment and Repair](#) in Paint and Coatings.
16. Paint the repaired area. Refer to [Basecoat/Clearcoat Paint Systems](#) in Paint and Coatings.
17. Install all of the related panels and components.
18. Connect the negative battery cable. Refer to [Battery Negative Cable Disconnection and Connection](#) in Engine Electrical.
19. Enable the SIR system. Refer to [SIR Disabling and Enabling](#) in SIR.