

Floor Panel Number 5 Cross Bar Replacement

Removal Procedure

Caution: Refer to [Approved Equipment for Collision Repair Caution](#) in Cautions and Notices.

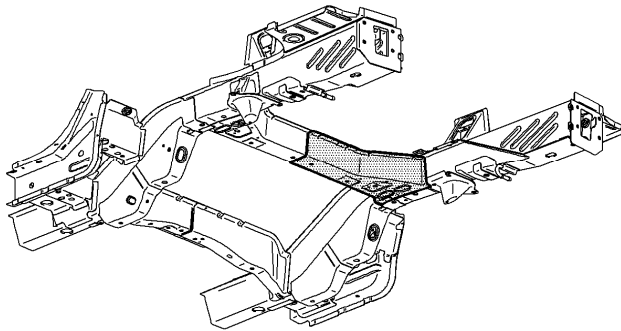

1. Disable the SIR system. Refer to [SIR Disabling and Enabling](#) in SIR.
2. Disconnect the negative battery cable. Refer to [Battery Negative Cable Disconnection and Connection](#) in Engine Electrical.
3. Remove all related panels and components.
4. Repair as much of the damage as possible to factory specifications. Refer to [Dimensions - Body](#).
5. Note the location and remove the sealers and anti-corrosion materials from the repair area, as necessary. Refer to [Anti-Corrosion Treatment and Repair](#) in Paint and Coatings.

Important: Do not damage any inner panels or reinforcements.

6. Locate and drill out all factory welds. Note the number and location of the welds for installation of the No.5 crossbar.
7. Remove the damaged No.5 crossbar.

Installation Procedure

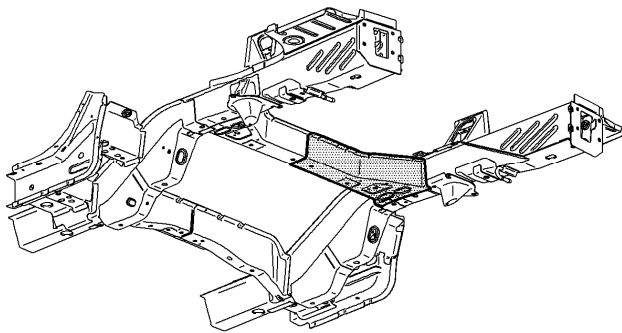

Important: If the location of the original plug weld holes can not be determined, space the plug weld holes every 40 mm (1 1/2 in) apart.

Some panels may have structural weld-thru adhesive. It is necessary to replace the weld-thru adhesive with an additional spot weld between each factory spot weld.

1. Drill 8 mm (5/16 in) plug weld holes in the service part as necessary in the locations noted from the original panel.
2. Prepare all mating surfaces as necessary.
3. Apply GM-approved Weld-Thru Coating or equivalent to all mating surfaces. Refer to [Anti-Corrosion Treatment and Repair](#).
4. Position the No.5 crossbar to the vehicle using 3-dimensional measuring equipment. Clamp the No.5 crossbar into place.
5. Plug weld accordingly.
6. Clean and prepare all welded surfaces.
7. Apply the sealers and anti-corrosion materials to the repair area, as necessary. Refer to [Anti-Corrosion Treatment and Repair](#) in Paint and Coatings.
8. Paint the repair area. Refer to [Basecoat/Clearcoat Paint Systems](#) in Paint and Coatings.

9. Install all related panels and components.
10. Connect the negative battery cable. Refer to [Battery Negative Cable Disconnection and Connection](#) in Engine Electrical.
11. Enable the SIR system. Refer to [SIR Disabling and Enabling](#) in SIR.